

A THEORETICAL APPROACH OF A NEW ELECTROMAGNETIC LAUNCH SYSTEM

**Laurian GHERMAN, Marian PEARSICA, Constantin STRÎMBU, Cristian-George
CONSTANTINESCU**

"Henri Coandă" Air Force Academy, Braşov, Romania (lauriang@gmail.com,
marianpearsica@yahoo.com, ccg_cristi@yahoo.com)

DOI: 10.19062/1842-9238.2016.14.2.9

Abstract: *This paper presents a theoretical study of a new design of an electromagnetic launch system (EMLS). The presented system does not follow the path of the previous systems. Instead to accelerate a conductor like in the previous systems this new design accelerates permanent magnets made ring, based on Halbach array arrangements. In the first part of the paper are presented the objectives of the new EMLS design. Then the existing solutions are presented in order to identify the limitations. Based on these observations a new design is presented. In order to analyze the interaction between all elements of this design, an interactive software package based on finite element method (FEM) was used to analyze, solve 3D electromagnetic field problems, and simulate the movement of Halbach array armature. All simulation data confirm this new design has a great potential of development.*

Keywords: *railgun, coilgun, Halbach array, Lorentz force*

1. INTRODUCTION

Different kinds of energy can be used in order to accelerate an object of mass m . If we want to obtain also great performance the chemical energy may be used. In time the launch systems based on chemical energy achieved their limits. In order to expand the limits of launch systems the electromagnetic energy can be used [1]. Different electromagnetic launch systems were developed in time. The most promising systems were based on Lorentz Force. According to the theory the Lorentz force is:

$$\vec{F} = q\vec{v} \times \vec{B} \quad (1)$$

Because in EMLS we don't use a singular charge but many, it is much easy to use the equation of Lorentz force based on current intensity. This form of Lorentz force is sometimes presented as Laplace force.

$$\vec{F} = I \cdot \vec{l} \times \vec{B} \quad (2)$$

$$F = I \cdot l \cdot B \cdot \sin \alpha \quad (3)$$

where α is the angle between vectors \vec{l} and \vec{B} ;

The force has a maximum when $\alpha = 90^\circ$ and a minimum (null) when $\alpha = 0^\circ$ or $\alpha = 180^\circ$.

This is an important remark because when we create an EMLS the magnetic flux density \vec{B} must be perpendicular on a current-carrying wire.

The objectives of this theoretical study are to accelerate a projectile of mass $m = 1\text{kg}$ from speed $v_0 = 0\text{ m/s}$ to $v_1 = 3000\text{ m/s}$ on a distance $x = 10\text{ m}$. The kinetic energy of the projectile with muzzle velocities $v_1 = 3000\text{ m/s}$ will be:

$$E_k = \frac{1}{2}mv^2 = \frac{1}{2} \cdot 1 \cdot 3000^2 = 4.5 \cdot 10^6 = 4.5\text{ MJ} \quad (4)$$

If we consider the projectile uniform accelerated on the length $x = 10\text{ m}$ we can find the acceleration value:

$$v_1^2 = v_0^2 + 2a(x - x_0) \quad (5)$$

$$a = \frac{v_1^2}{2 \cdot x} = \frac{9 \cdot 10^6}{20} = 4.5 \cdot 10^5 \text{ m/s}^2 \quad (6)$$

The value of force acting on projectile must be:

$$F = m \cdot a = 1 \cdot 4.5 \cdot 10^5 = 450\text{ kN} \quad (7)$$

According with these determinations, we are looking for an EMLS able to create a 450 kN force which will act on projectile on the length of 10 m .

2. THE EXISTING SOLUTIONS

Different designs of EMLS were studied in time. One of the best designs is called railgun. A railgun consists of two parallel conductors called rails and a sliding conductor between rails called armature. The projectile is mechanically connected with armature.

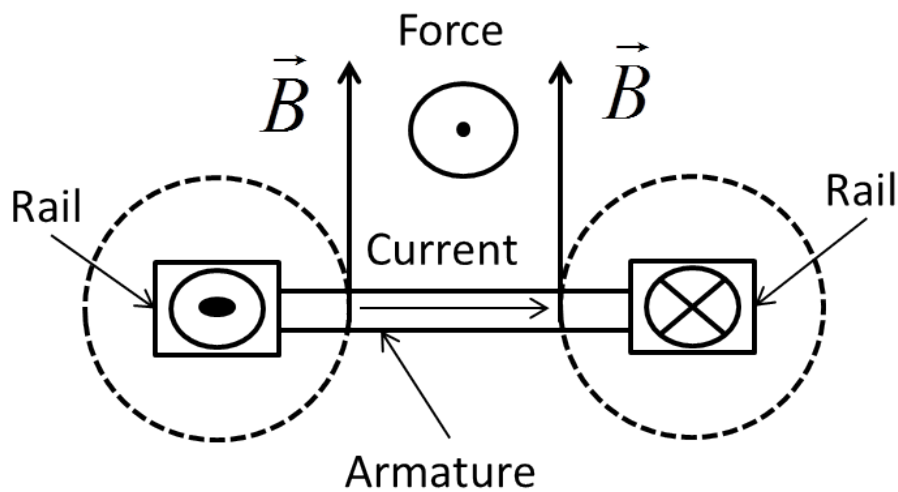

FIG. 1 Railgun

A very high current I flows through rails. The combination between this simple design and very high currents creates the condition to obtain a great Lorentz force on armature according with figure 1.

Studying figure 1 we can observe some advantages of this design:

- the magnetic flux density \vec{B} is perpendicular on armature;
 - the current I create the magnetic field around rails and the current on armature. By increasing the current I the Lorentz force is also increased;
 - the length of rails can be calculated according with the performance of the launcher.
- The expression of force acting on armature can be approximate according to (8) [2].

$$F = \frac{1}{2} I^2 L' \quad (8)$$

where L' is magnetic gradient inductance.

Because this design uses only straight conductors the value of magnetic gradient inductance is very low. The only way to obtain a high value of force is to increase the current I which flows through conductors.

We can name this design a **current based EMLS**.

Another important advantage of this design is the angle between magnetic field and armature, which is 90° . Even the magnetic field created by rails is not so strong compared with a magnetic field created by a coil, the armature is touching the rails and use very efficient the magnetic field created.

This big advantage comes also with a big disadvantage of this design: sliding contacts between armature and rails.

In order to create a great EMLS design we should preserve the advantages of railgun design and to avoid his great weakens-sliding contacts. We are looking also for a design which doesn't use high currents to obtain desired force.

The second direction of development of EMLS is induction coilgun. In order to reduce the value of current I the rails can be replaced by coils. By using coils we can obtain the same value of magnetic flux density \vec{B} created by the rails with less amount of current. The current inside armature can be obtained by using induction instead of sliding contacts.

$$u_i = -\frac{d\phi_B}{dt} \quad (9)$$

$$u_i = -\frac{d}{dt}(BA \cos \theta) = -\left(\frac{dB}{dt}\right)A \cos \theta - B\left(\frac{dA}{dt}\right) \cos \theta + BA \sin \theta \left(\frac{d\theta}{dt}\right) \quad (10)$$

where θ is the angle between \vec{B} and \vec{n} (normal unit of surface area A).

We assume the magnetic field is uniform distributed in space.

The coilgun design was developed based on Faraday's law.

In this particular case the only variable in (10) is the magnetic field, the surface A and angle θ being constant. The Faraday's law can be written:

$$u_i = -\left(\frac{dB}{dt}\right)A \cos \theta \quad (11)$$

A possible design consists of coils which create a gun barrel and allow a projectile made by aluminum to move inside them, presented in figure 2.

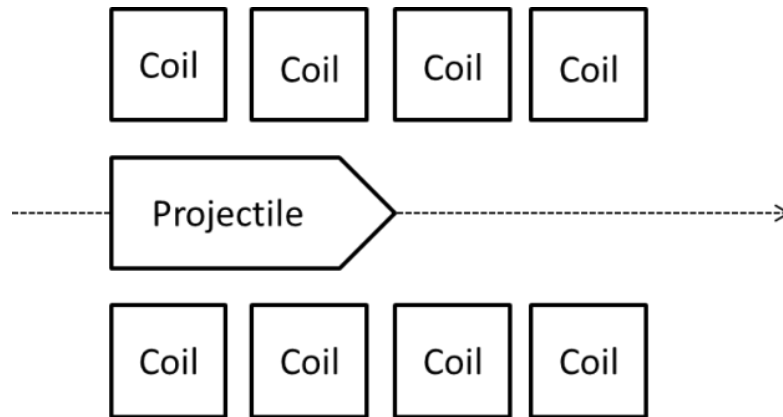

FIG. 2 Induction coilgun

The axial component of magnetic flux density \vec{B}_a , inside coil creates the induced current inside projectile, which interact with radial component of magnetic flux density \vec{B}_r .

The induced current depends on rate of change of the axial magnetic flux density \vec{B}_a and the radial magnetic flux density \vec{B}_r depends on amount of magnetic flux. The magnetic flux is created by the coil and is the only one which induces current in projectile, providing simultaneously the radial magnetic field on induced current [4-6].

It is difficult to control with a coil both the rate of change of the axial magnetic flux density \vec{B}_a and the radial magnetic flux density \vec{B}_r . Also it is difficult to control the phase of induced current in projectile and the phase of the radial magnetic flux density \vec{B}_r .

Compared with railgun, the coilgun creates a strong magnetic field using only a fraction of current and avoiding sliding contacts.

The coilgun design is also much complex than railgun because the position of projectile must be synchronized with powered coils. Also the coilgun use AC currents instead DC currents and the phase must be tighten controlled.

In order to increase the radial magnetic flux density \vec{B}_r and to decrease the current inside the coil a design with magnetic circuit made by ferromagnetic materials was proposed. The magnetic circuit creates also a zone where the magnetic field is radial on conductor, in our case a ring (figure 3) [7]. The E shaped design use the soft magnetic materials and use the Lorentz force to accelerate projectiles but that design does not allow to control the difference of phase between induced current in projectile and the phase of the radial magnetic flux density \vec{B}_r [8].

We can name this design a **magnetic flux density based EMLS**.

The induction coilgun design presented in figure 3 is important for our study because the projectile is not located inside a gun barrel like in railgun and classical coilgun but is located outside acceleration system.

Because we use electromagnetic energy to accelerate the projectile we do not need a barrel like guns which use chemical energy. This is a very important remark.

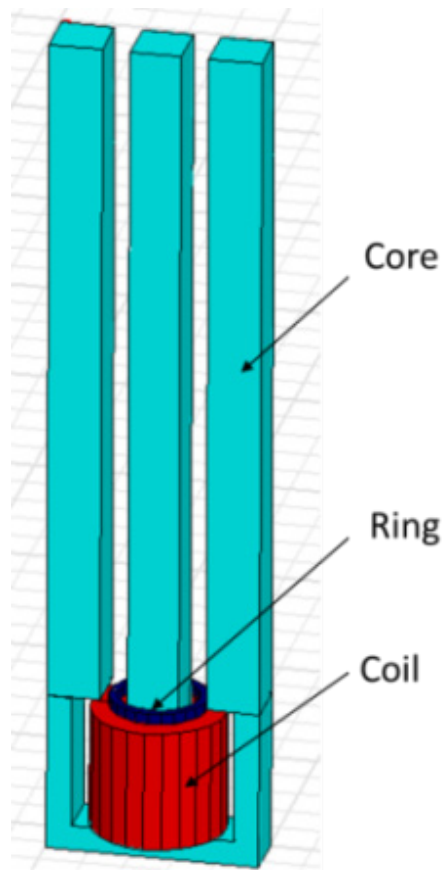

FIG. 3 E shaped coilgun

At this point we can identify the main aspects which should be taken into consideration when a design of an EMLS is created:

- the Lorentz force should be used to accelerate the projectile;
- the magnetic field should be perpendicular on current-carrying conductor;
- the contact between the projectile and the accelerator should be avoided.

If possible, the EMLS should be simple as a railgun and efficient as a coilgun. A design which respects all this conditions is presented in the following chapter.

3. THE NEW HALBACH ARRAY GUN

Before the presentation of a new electromagnetic launch system we will analyze again the equation of Lorentz force (3).

In order to obtain maximum force the angle must be $\alpha=90^\circ$.

It is not necessary to create the magnetic field by using current I . The magnetic field can be created by an independent source like permanent magnets. The IT magnetic flux density B can be easily obtained with permanent magnets. A value of $10T$ is relatively hard to obtain, so increasing the force value in this way is not justified. In the near future it is possible to obtain permanent magnets with magnetic field larger than $1T$.

The value of current I can be easily increased as we saw in railgun design. Because the conductor must be linked with a powerful current source the moving element can be the permanent magnet.

The permanent magnet can act as an armature like in railgun design with a projectile mechanically attached.

The next element is l (length of conductor inside magnetic field) and apparently its value cannot be modified, but if we use more wires (let's say N turns) like in a coil we can increase easily the value of force by N times.

If we manage to increase the number of conductors inside magnetic field by N times, we can increase the total force acting on armature by N times [9]. This is an easy way to increase the force. This number depends by the size of wire and the space volume where the magnetic field is strong enough to create a useful Lorenz force. For our design the determined value of N is 4000.

In order to obtain a magnetic field perpendicular on conductors, a circular Halbach array with linear field inside should be used.

For our design we chose a circular Halbach array made by 8 permanent magnets like in figure 4.

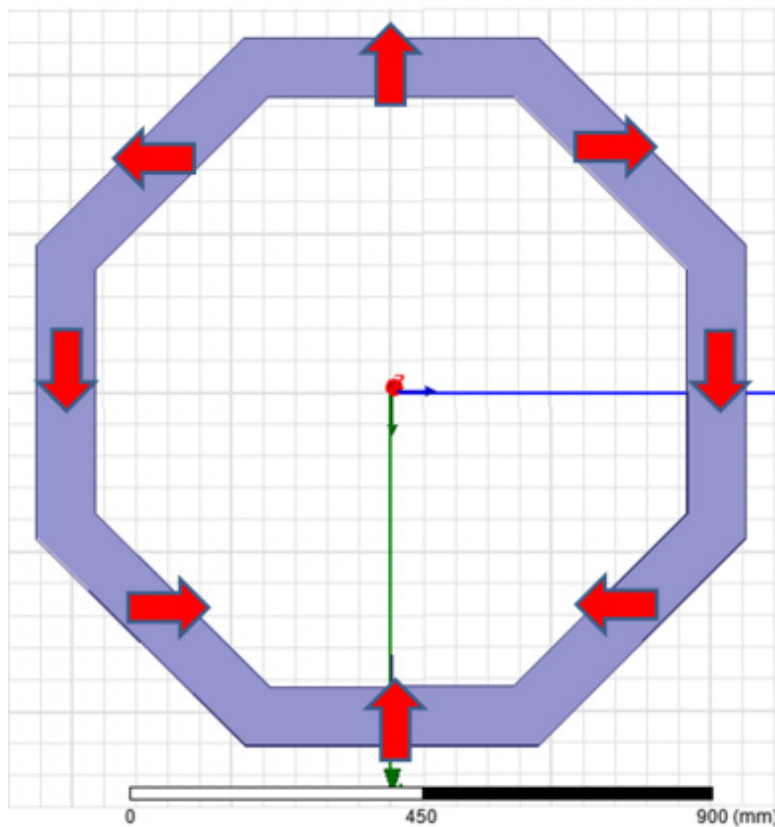

FIG. 4 Cylindrical Halbach array with uniform field inside

We marked with arrows the direction of magnetization of each piece of permanent magnet from circular Halbach array. We obtain a magnetic field with linear flux lines from the bottom of figure to the top.

The **Maxwell** interactive software package that uses the finite element method (FEM) was used to simulate the magnetic field created by the circular Halbach array.

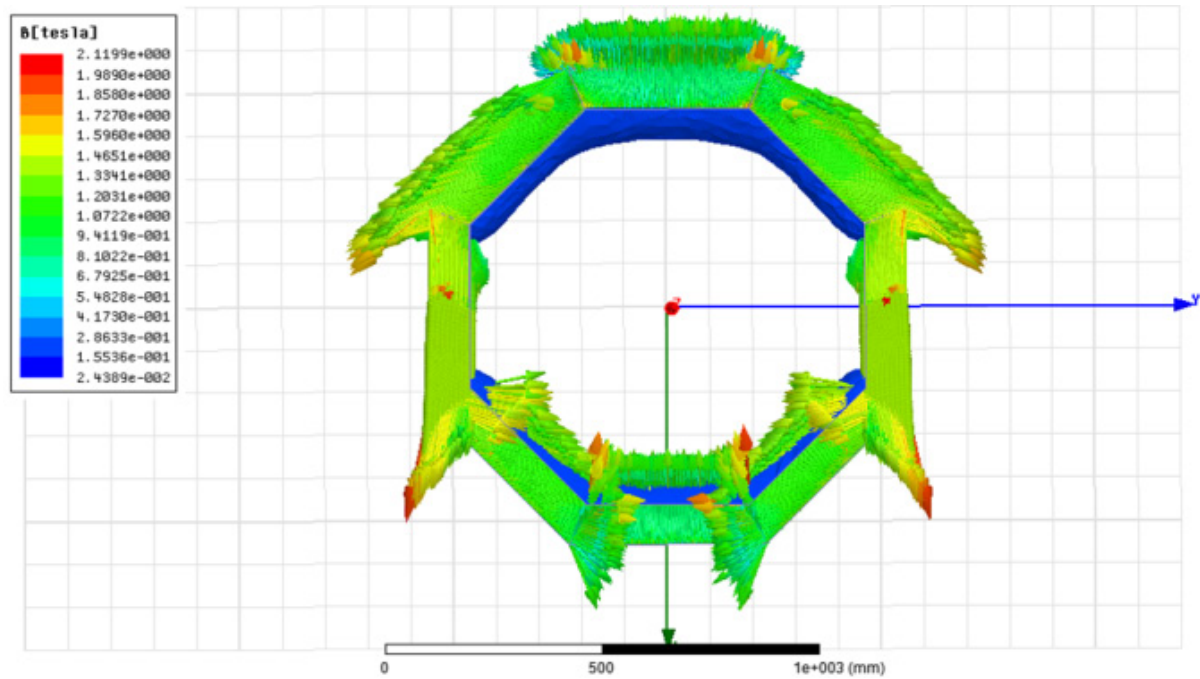

FIG. 5 Top view of a circular Halbach array

In figure 5 is displayed a simulated top view of direction of magnetization of each piece from circular Halbach array.

The two marked areas on top and bottom of figure represent the space where magnetic field is strong enough to act on conductors.

In order to obtain a strong force, the conductors must be placed inside these two marked areas. Their volume influences the number of conductors N .

Because the magnetic field is not uniform, on every conductor will act a different value of magnetic field density B . In the center of array the magnetic field is very weak. We use this space to connect conductors in a proper way.

According to the theory the magnetic flux lines are linear inside array.

In figure 6 is displayed a simulated side view of the array magnetic field. We can also observe the magnetic field is not uniform, so if we place conductors nearby permanent magnets (where the magnetic field is strong enough), on every conductor will act a different value of magnetic flux density B . Also in the center of array the magnetic field is very weak.

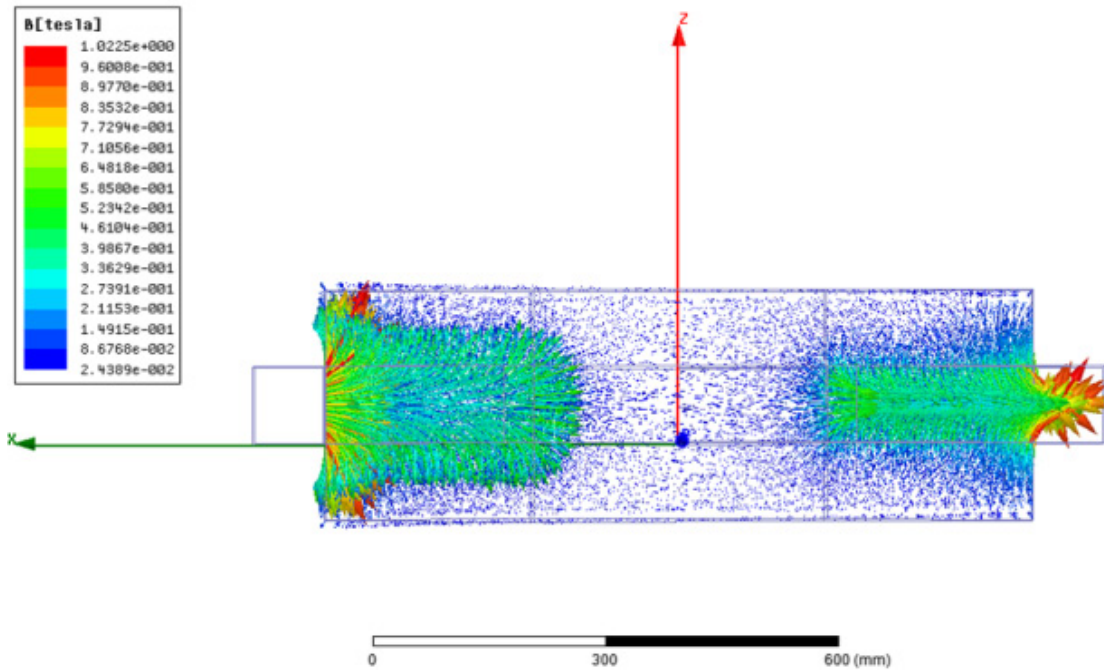

FIG. 6 Side view of a magnetic field created by a circular Halbach array

The non-moving part of electromagnetic launch system is represented by conductors arranged as displayed in figure 7.

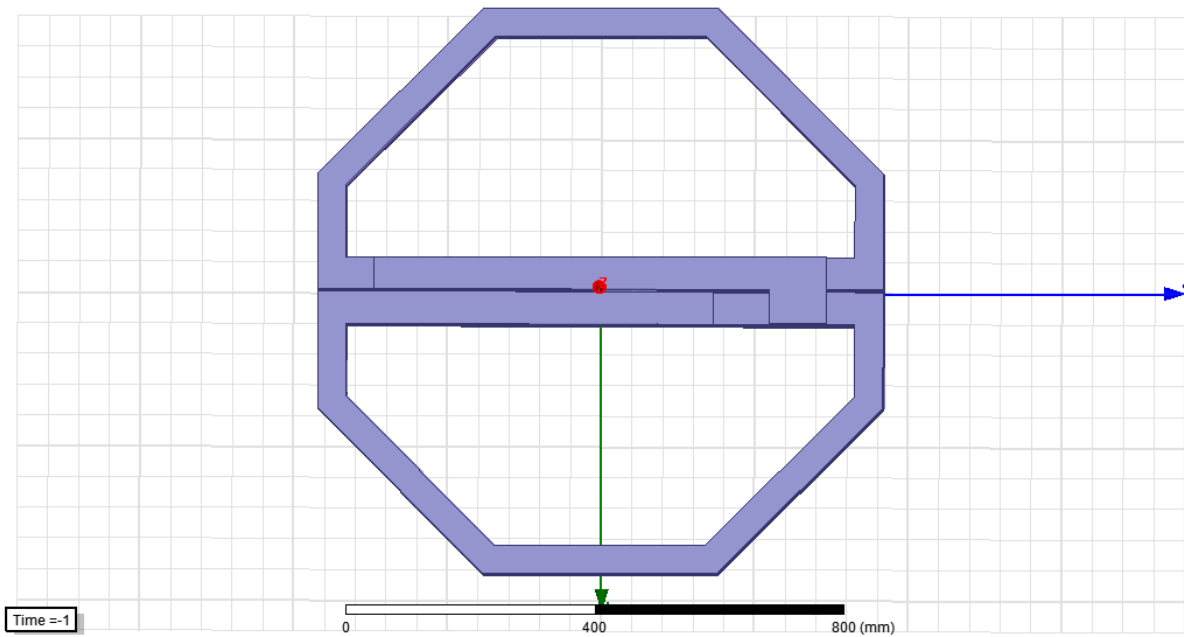

FIG. 7 Top view of conductors

In order to obtain a cumulative Lorentz force acting on Halbach array on z positive direction the sense of current in conductors placed in bottom of figure 7 must be the same like in conductors placed on top.

This is not possible with a normal coil configuration. For this reason we use the center of the array to connect conductors. Because the magnetic field in the center of array is weak, the Lorentz force created is also weak.

The conductors are placed where the magnetic field has the highest value on x axis of the array and are placed in such a way to obtain all conductors with the same direction of the flowing current.

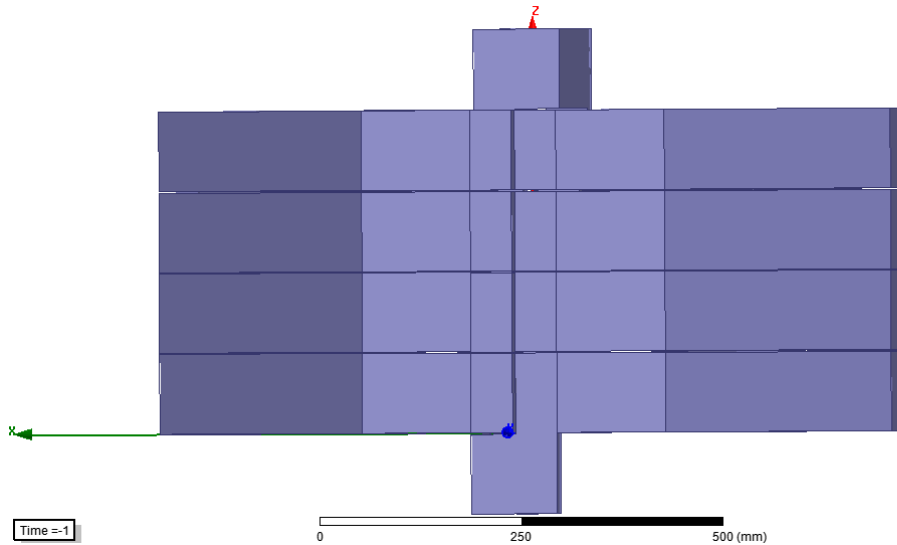

FIG. 8 Side view of conductors

For our simulation the conductors are divided in 4 stages of the length equal to the one of permanent magnets, like in figure 8. For each stage we have two sets of conductors in order to obtain the Lorentz force with same orientation on both sides of Halbach array. According with the destination of EMLS, the number of stages may be increased in order to obtain a desired distance of acceleration. All conductors are connected to the same DC power source.

The magnetic flux density B is acting on conductors and with this configuration we have N conductors of length l placed inside magnetic field.

The conductors are arranged in such a way to carry the same intensity of current in each of them. We can increase now the value of current in order to obtain the desired value of force.

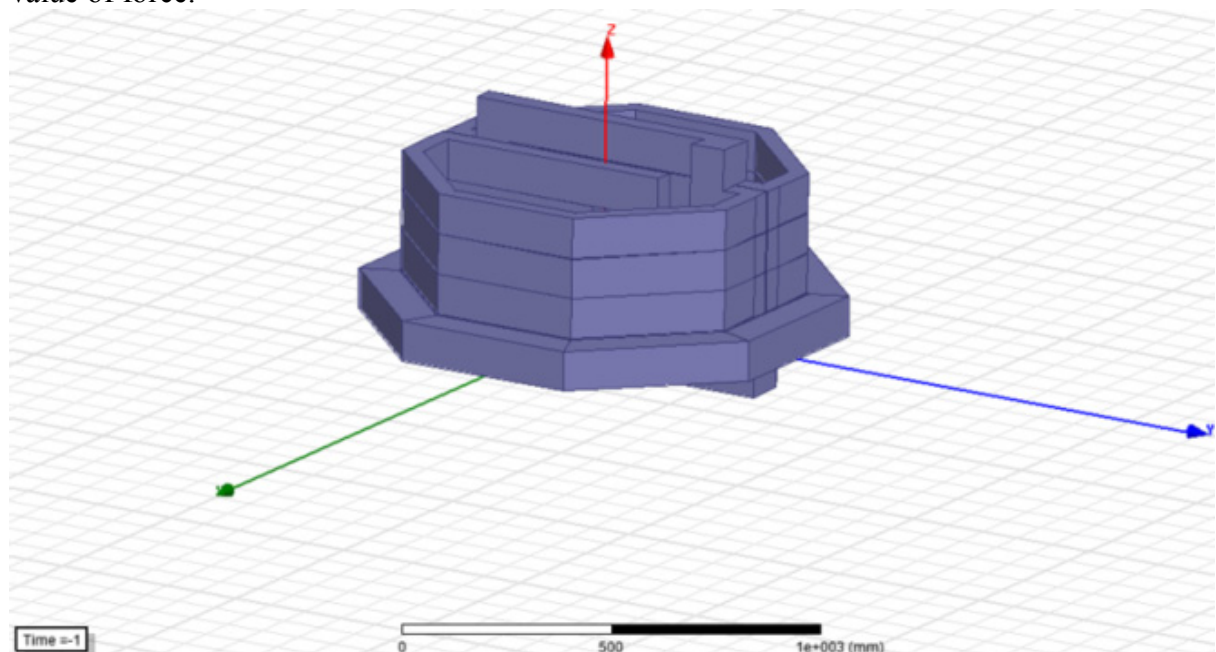

FIG. 9 The Halbach array launch system

Figure 9 shows this new design of an electromagnetic launch system. It is a different approach.

The moving part is placed outside like in E shaped coilgun but now the ring is made by permanent magnets instead of a conductor.

The static parts which accelerate the Halbach array don't form a gun barrel like in railgun and coilgun designs.

The Halbach array is the armature which is moving outside conductors in z positive direction. This design is indeed simple as a railgun design and efficient as a coilgun design.

In the following chapter the simulation results of this new design are presented. Even every conductor of this design has the same current, the magnetic field acting on every conductor is different, according with figure 6.

In order to obtain a well approximated value of the cumulative force acting on Halbach array ring, we used the above mentioned **Maxwell** interactive software package based on finite element method (FEM) to analyze, solve 3D electromagnetic field problems, and simulate the movement of Halbach array armature.

4. THE SIMULATION RESULTS

The permanent magnets with a height of $100mm$ are arranged as a cylindrical Halbach array with magnetic field inside in one direction, along x axis. The conductors are placed in cylinder inner space and are divided into four stages. The number of stages depends on the necessary acceleration distance to obtain desired muzzle velocity of projectile. In our simulation the acceleration distance is $400mm$.

Each stage has two sets of conductors in order to control the direction of current inside. In this way the direction of Lorentz force is the same for both sets of conductors of each stage. The conductors are powered with a DC source. Each set of conductors can accommodate 4000 separate conductors. The inner radius of Halbach array is $R_i = 500mm$ and the outer radius is $R_o = 600mm$. The dimensions of Halbach array ring were determined taking into consideration the value of magnetic field in the center of the ring (very low value) and the volume of 4000 conductors accommodated in the area of strong magnetic field. The total mass of moving object (armature plus projectile) is $m = 1kg$.

The interaction between all elements of the design was checked for different values of current in conductors. The results for $I=500A$ are presented in the following graphs.

The time variation of Lorentz force acting on z positive direction on armature is presented in figure 10.

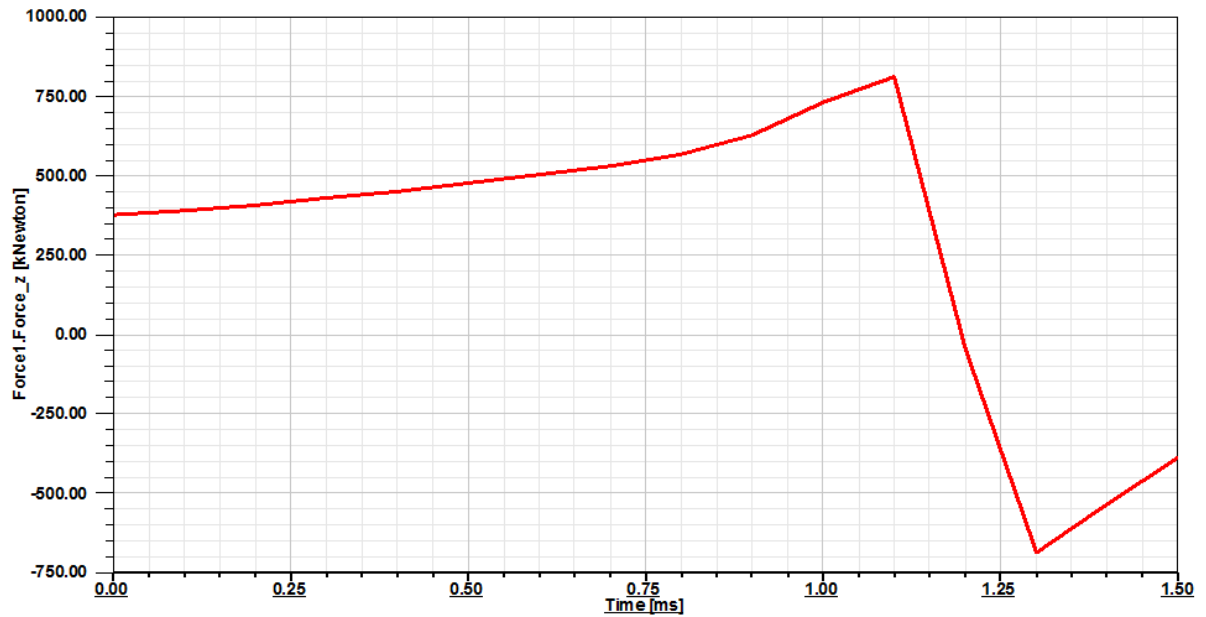

FIG. 10 Lorentz force acting on armature

The Lorentz force acting on armature starts at $377kN$ and increases in time up to $811.61kN$.

When the armature left conductors the force decreases rapidly and acts in opposite direction. This is not bad because our intention is to accelerate a projectile and at this stage the projectile is released by armature.

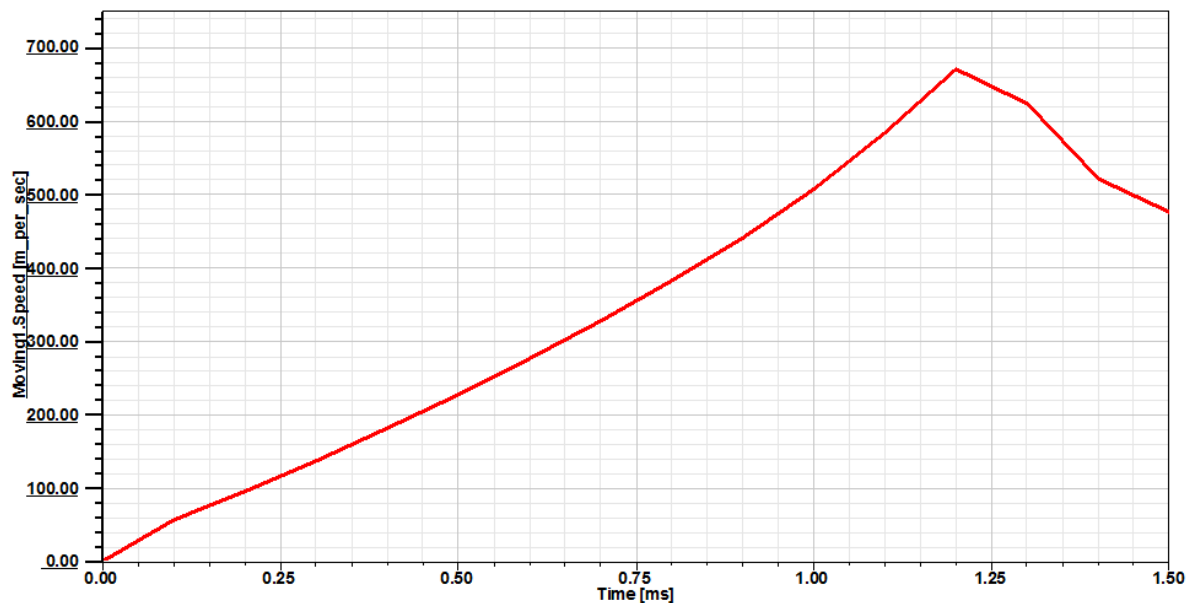

FIG. 11 Muzzle velocity of armature

Based on force acting on armature the muzzle velocity is calculated. In figure 11 the time variation of the speed of the armature is displayed. The armature is accelerated up to $669m/s$. At this point the projectile is released and the speed of armature is slowing down.

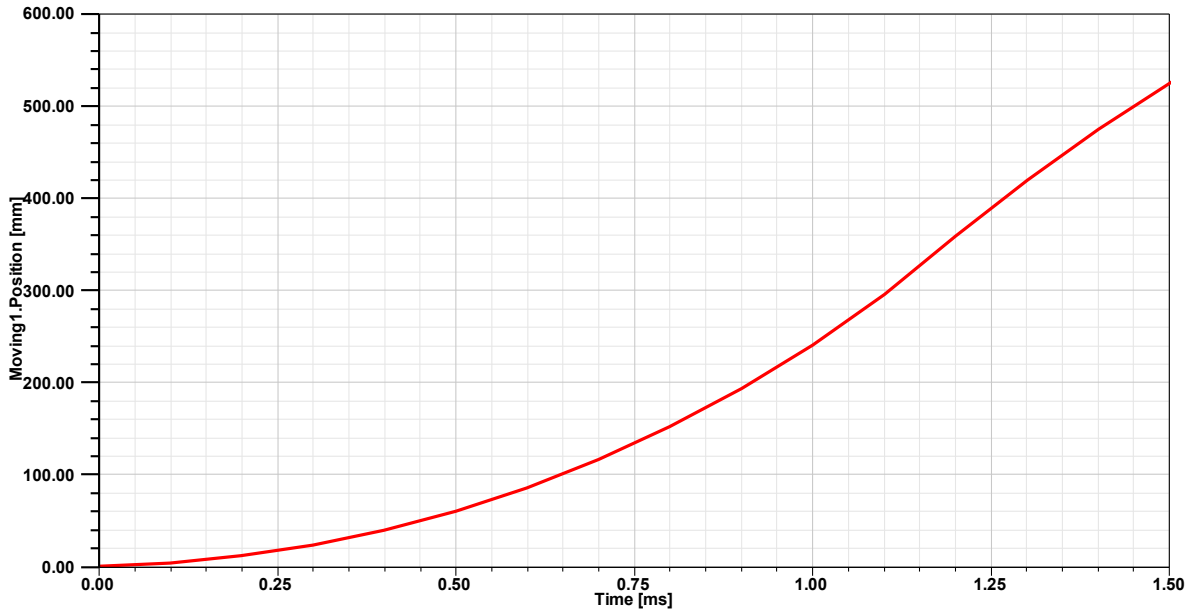

FIG. 12 The moving position of armature

In figure 12 is displayed the position of Halbach array ring in time. The simulated acceleration distance is only 400mm . According to figure 12 the armature leaves the accelerator in 1.26ms . For our simulation the length of power current pulse should be 1.26ms .

In figure 13 are displayed the time variation of force, speed and moving position of armature, together.

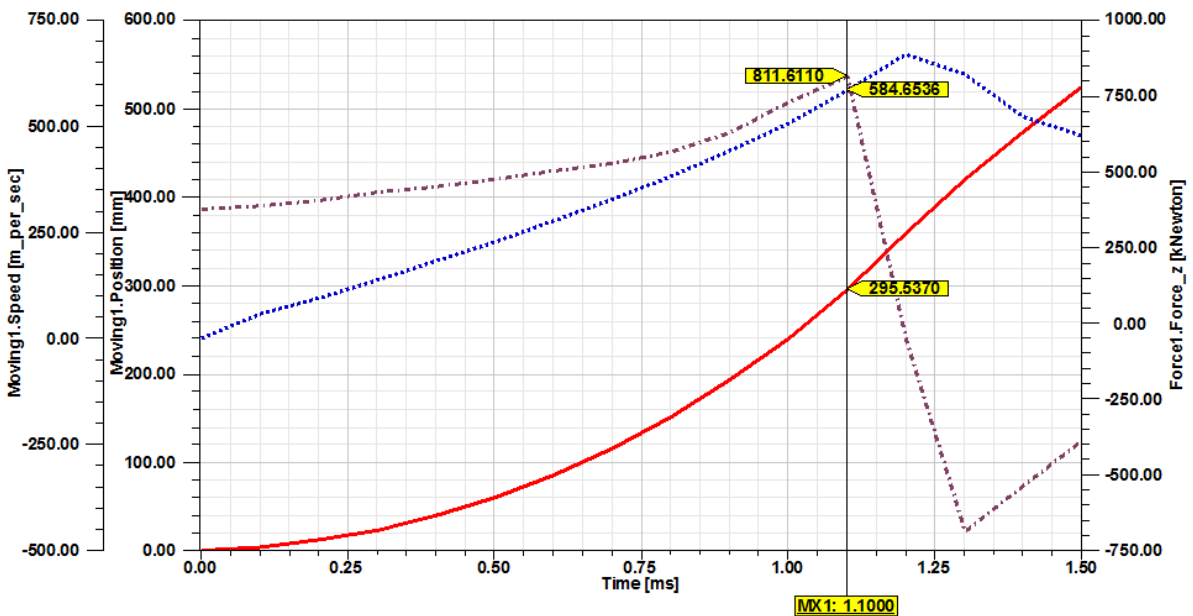

FIG. 13 The time variation of force, speed and moving position of armature

From figure 13 we can observe the maximum force is obtained when the armature is in the third stage (of four) of acceleration, 295mm .

In the last stage of acceleration the force decreases rapidly because fewer conductors are inside magnetic field and the direction of magnetic field acting on conductors is different.

If we increase the number of stages in order to obtain the length of acceleration $x = 10m$ we will expect the force acting on armature will decrease only during the last stage.

The maximum force obtained on our simulation was $811.61kN$ which is more than the necessary value to achieve our objective. The muzzle velocity of armature after $400mm$ of acceleration is $669m/s$.

The average force acting on projectile calculated based on these values is $550kN$. Based on these values, we conclude that is possible to obtain the desired muzzle velocity of $3000m/s$.

This great performance was obtained using a $1T$ magnetic field and a $500A$ current.

CONCLUSIONS

This design has great advantages over current EMLS. The static part of accelerator can be easily powered with high currents according with destination of accelerator.

The number of conductors and the length of acceleration path can be calculated according with destination. For instance if we use the same configuration with a length of acceleration equal to $10m$ the muzzle velocity of armature will be $3000m/s$, like in a railgun design. Our design uses a current of $500A$ and there is no contact between stator and armature; the armature is moving freely during acceleration.

Despite the fact our study doesn't present an optimized EMLS it theoretical proves is possible to achieve hypervelocity with $1T$ magnetic field and low values of currents.

Also because the armature is outside acceleration path we can use multiple Halbach array launch systems to accelerate a projectile or other object with mass greater than $1kg$.

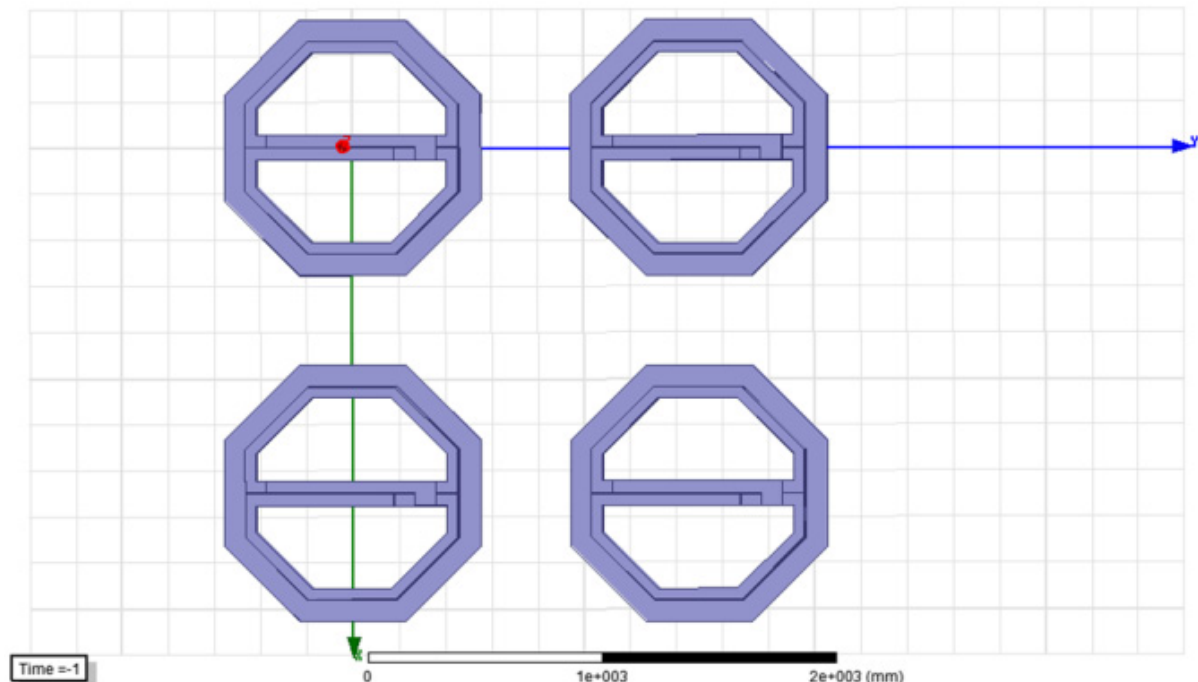

FIG. 14 Configuration with four systems

The object which will be accelerated is placed in the center of configuration shown in figure 14, and is mechanically connected with armatures. With this configuration we can reduce the length of acceleration or increase the mass of projectile for the same muzzle velocity and the same value of current.

Taking into consideration all these aspects we can conclude this Halbach array gun has a great potential of development, and we consider it worth to do.

REFERENCES

- [1] I. R. McNab, and F. C. Beach, *Naval railguns*, *IEEE Trans. on Magnetics*, vol. 43, no. 1, pp. 463-468, 2007;
- [2] M. Ghassemi, Y. Molayi Barsi, and M. H. Hamed, *Analysis of force distribution acting upon the rails and the armature and prediction of velocity with time in an electromagnetic launcher with new method*, *IEEE Trans. on Magnetics*, vol. 43, no. 1, pp. 132-136, January 2007;
- [3] A. Balicki, Z. Zabar, L. Birenbaum, and D. Czarkowski, *On the design of coilguns for super-velocity launchers*, *IEEE Trans. on Magnetics*, vol. 43, no. 1, pp. 107-110, January 2007;
- [4] Kurt A. Polzin, Jake E. Adwar, Ashley K. Hallock, *Optimization of Electrodynamic Energy Transfer in Coilguns with Multiple, Uncoupled Stages*, *IEEE Trans. on Magnetics*, vol. 49, no. 4, pp. 1453-1460, April 2013;
- [5] L. Wenbo, W. Yu, G. Zhixing, Y. Zhongming, C. Weirong, *Connection Pattern Research and Experimental Realization of Single Stage Multipole Field Electromagnetic Launcher*, *IEEE Trans. on Plasma Science*, vol.41, no. 11, pp. 3173-3179, November 2013;
- [6] Z. Du, T. Zhan, J. Ruan, G. Huang, Y. Zhang, Y. Yao, K. Liu, D. Huang, W. Guan, *Research on Electromagnetic Performance Affected by Shielding Enclosure of a Coil Launcher*, *Electromagnetic Launch Technology (EML)*, 2012 16th International Symposium, ISBN 978-1-4673-0306-4;
- [7] L. Gherman, M. Pearsica, C. Strimbu, and C.G. Constantinescu, *Induction coilgun based on "E-shaped" design*, *IEEE Trans. on Plasma Science*, vol.39, no. 2, pp. 725-729, February 2011;
- [8] H. D. Fair, *Progress in electromagnetic launch science and technology*, *IEEE Trans. on Magnetics*, vol. 43, no. 1, pp. 93-98, January 2007;
- [9] L. Gherman, *Halbach array launch system*, Review of the Air Force Academy, ISSN 1842-9238, no.1, 2016, DOI: 10.19062/1842-9238.2016.14.1.11.