

GAS TURBINE ENGINE COMBUSTORS AND THE ESTIMATION OF THEIR PRESSURE LOSS

Béla VARGA, Gyula ÓVÁRI, László KAVAS

National University of Public Service, Budapest, Hungary (varga.bela@uni-nke.hu, ovari.gyula@uni-nke.hu, kavas.laszlo@uni-nke.hu)

DOI: 10.19062/2247-3173.2017.19.1.41

Abstract: *The combustor is a crucial component of the gas turbine engines through which the chemical energy of the fuel is converted into thermal energy preferably with minimal pressure loss and maximal burner efficiency meanwhile the emitted harmful pollutants and the deposit must be minimised. That condition can be achieved through highly turbulent flow which description with numerical methods is difficult even today. In accordance with it the design of combustor is based more empiricism collected from the previous experiences and tests. In this paper we deal with the pressure loss in the combustors examining what kind of methods, empirical equations can be used to predict the estimated value of pressure loss. Using the Fanno and Rayleigh line flow we tried to determine the pressure loss in the combustor of TV2-117A turboshaft engine built in Mi-8 helicopter.*

Keywords: *gas turbine engine, combustor, pressure loss, Fanno line flow, nonisentropic irreversible flow, Rayleigh line flow, heat drag.*

1. HISTORIC REVIEW

By the end of World War II aircraft with traditional propulsion system (piston engine with propeller) practically achieved their limits. The flying speed of fighters approached 750 km/h and the flying altitude 12 km, meanwhile some special reconnaissance aircraft could reach 14 km. These limits considering the aerodynamics of aircraft and their propulsion systems were well known even before the war but that time the aircraft performance of participated countries were well below to the above mentioned limits. However, there was no strong intention in any country to find new revolutionary way of aircraft propulsion some inventors tried find new solutions. One of them was the British Frank Whittle whose work in this field unchallenged. His gas turbine (Fig 1.) in late 1930s had every element a modern gas turbine today has.

The first operational gas turbine, *Heinkel HE S3*, built in aircraft, was invented and built by Hans von Ohain, a German scientist. It was built in a Heinkel HE 178 aircraft, which maiden flight was made in August 27, 1939 and become the first ever aircraft propelled by gas turbine engine. In the 1940s the gas turbine engines became more and more frequently used in different aircraft, for example the German Messerschmitt Me 262, Arado 234, or the British Gloster Meteor (however this last one didn't take part in the air battles at the end of the war).

The early gas turbine engines suffered still numerous children's illnesses because of the lack of appropriate materials and technologies. The inventors practically were in the dark.

The problems emerged again and again had to be solved without any cooperation because before and during the WW II there was no any cooperation even within the Allied Forces. Every component of the gas turbine engine had its own problems. Very low compressor pressure ratio (2-3), and turbine inlet temperature due to the weak heat resistance of turbine blades and the lack of turbine cooling, meanwhile the component efficiencies were also very low, but the most serious problem was to create a heat resistant but efficient combustor. It proved to be a formidable task for both groups and, in Whittle's case, combustion problems dominated the first three years of engine development. Considering the isolated developing processes quite many different shapes, sizes, structures, vaporization solution appeared (Fig. 2.) that time.

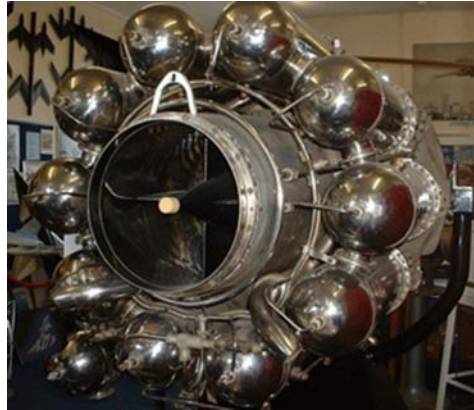

FIG. 1. Frank Whittle's gas turbine engine [1]

In the 1950s the gas turbines irrevocably conquered the aviation. By that time, the development work carried out in the UK, Germany, and the United States had established the basic design features of aero-engine combustors that have remained largely unchanged. The main components are a diffuser for reducing the compressor outlet air velocity to avoid high-pressure losses in combustion, a liner (or flame tube) that is arranged to be concentric within the outer combustor casing, means for supplying the combustion zone with atomized or vaporized fuel and, with tubular liners, interconnectors (or cross-fire tubes) through which hot gases can flow from a lighted liner to an adjacent unlighted liner.

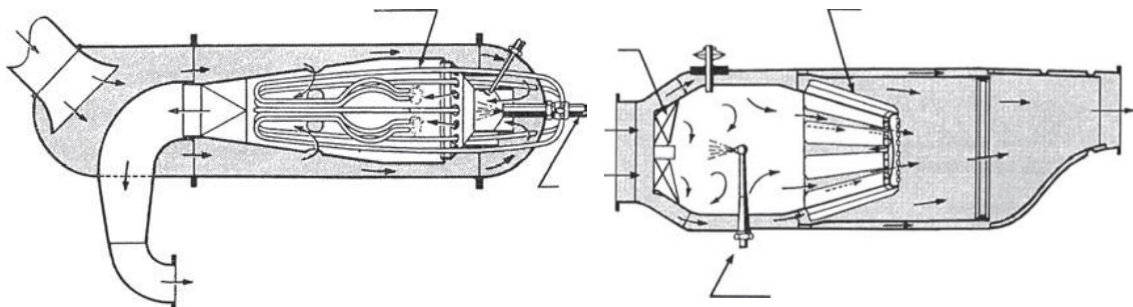

FIG. 2. To the left Frank Whittle's combustor, to the right combustor of JUMO 004 engine [5]

Since that the development has been continuous but without major breakthrough. Until the 1970s the designers of combustors were fully occupied with providing stable operation, low pressure loss and high burner efficiency, however, unfortunately, the last two are in antagonistic relation with each other.

Until 1980, little attention was paid to pollution, but since that time different ICAO regulations (ICAO '86, CAEP2-tól CAEP-8-ig) have pressed the manufacturers to decrease the emitted pollutants continuously and today that is the main aspect of developments.

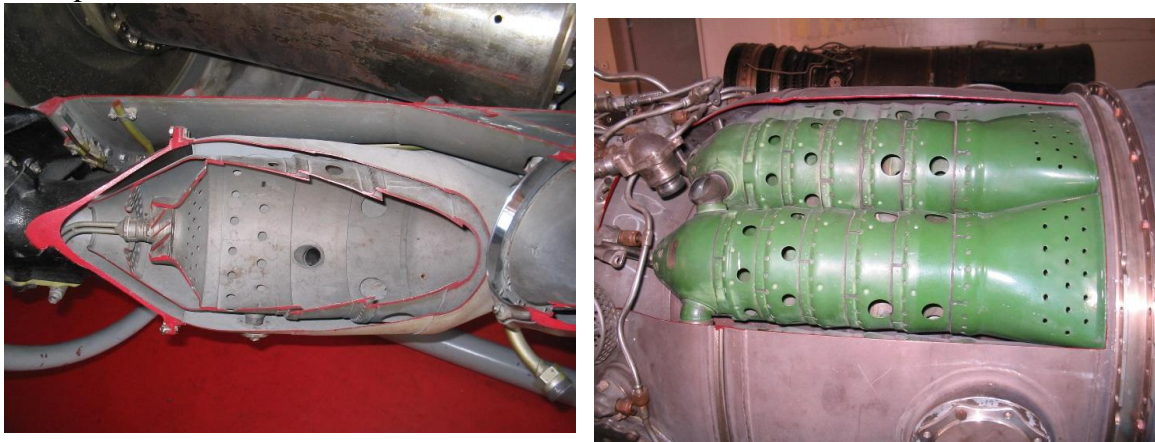

FIG. 3. To the left can (or tube) type, to the right tuboannular combustor [own photo]

In the last 70 years three different types of combustor layout have become widespread, namely the can or tube type, tuboannular (Fig. 3) and annular combustors (Fig. 4). Practically the first two due to their disadvantages are not used today. From the 1960s the annular combustors and their modifications have become generally used. In this type, an annular liner is mounted concentrically inside an annular casing. In many ways it is an ideal form of chamber, because its clean aerodynamic layout resulted a compact unit, lower weight and lower pressure loss (<5%) than other combustor types and in addition in the inlet section of the turbine they provide uniform flame temperature.

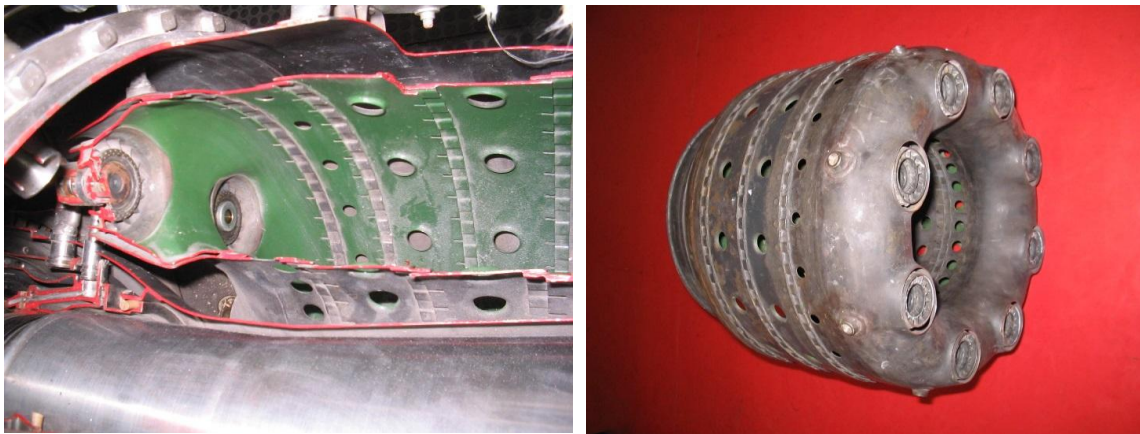

FIG. 4. To the left annular combustor, to the right an annular liner [own photo]

Nevertheless, the combustors had to be adapted to the continuously increasing performance of other gas turbine engine components. The combustor inlet temperature changed from at about 450 K to 900 K and the exit temperature from 1100 K to 1800 K or more (difficult to find correct data). The pressure changed from 5 bar to 50 bar.

Driven by the increased temperatures of the gas turbines and the need for improved emission control, significant development efforts have been made to advance the combustion hardware, by way of adopting sophisticated materials and processes. Traditionally combustor components have been fabricated out of sheet nickel-base superalloys.

Hastelloy X, a material with higher creep strength was used from 1960s to 1980s. Nimonic 263 was subsequently introduced and has still higher creep strength. As firing temperatures further increased in the newer gas turbine models, HA-188, a cobalt based superalloy has been recently adopted for some combustion system components for improved creep rupture strength. In addition to designing with improved materials, combustion liners and transition pieces of advanced and uprated machines involving higher temperatures are given a thermal barrier coating (TBC). The coating serves to provide an insulating layer and reduces the underlying base metal temperature [8].

Due to the above mentioned improvements some hundreds hour operational time of early gas turbine combustors has increased to some tens of thousands operational hours.

2. MAIN REQUIREMENTS IN THE DESIGN OF COMBUSTOR

The designer of gas turbine combustors has to face numerous hardships to meet the multiple requirements a combustor have to perform. The most important of them are bellow.

- Complete combustion to avoid the waste of fuel and to provide high burner efficiency;
- Minimal total pressure loss;
- The combustion must take place in turbine and never in turbine;
- The deposit creation on the liner must be avoided, because it can cause further pressure loss, hot spots, and they are signs of insufficient burning;
- Easy ignition and relight;
- Long lives, without any cracks and failure, because it can cause fatal accident;
- The exit temperature must be uniform both in space and time avoiding the heat stress;
- Stable flame in any operating conditions, air mass flow rate, flow speed and pressure;
- The flame in the combustor shouldn't be prone to flame out;
- Minimal weight and volume [7].

Minimal pressure loss is one of the basic requirements of any gas turbine combustor. The pressure loss is due to two different reasons. First effect is the friction of the working fluid flows through the combustor, while the second is the nonisentropic and irreversible heating in the combustor. None of them can be eliminated totally, what is more improving the mixing of air and fuel the necessary turbulence increases the pressure loss, consequently the turbulence shouldn't be any higher than necessary to ensure the good mix.

The two effects can be analyzed with two different methods, which are the Fanno and Rayleigh line flow models. These flow models have many analytical uses, most notably involving aircraft engines, for instance, the combustion chambers, which usually have a constant area and the fuel mass addition is negligible. The Fanno line flow is suitable to examine flow with friction but without heat addition, meanwhile the Rayleigh line flow is suitable to determine the pressure loss of flow with heat addition, but without friction.

3. FANNO LINE FLOW

Fanno line curve represents the relationship between the entropy and temperature of fluid flow in $S=S(T)$ coordinate system when the irreversible velocity change due to friction is associated with entropy change.

Fanno flow refers to adiabatic, steady ideal gas flow through a constant (or near constant) area duct where the effect of friction is considered. The change of entropy can be deducted using the energy conservation, mass conservation and ideal gas law, while the friction can be taken into consideration through the impulse momentum theory. The above mentioned equations can be used to plot the Fanno line, which represents a locus of states for given Fanno flow conditions on an T-S diagram.

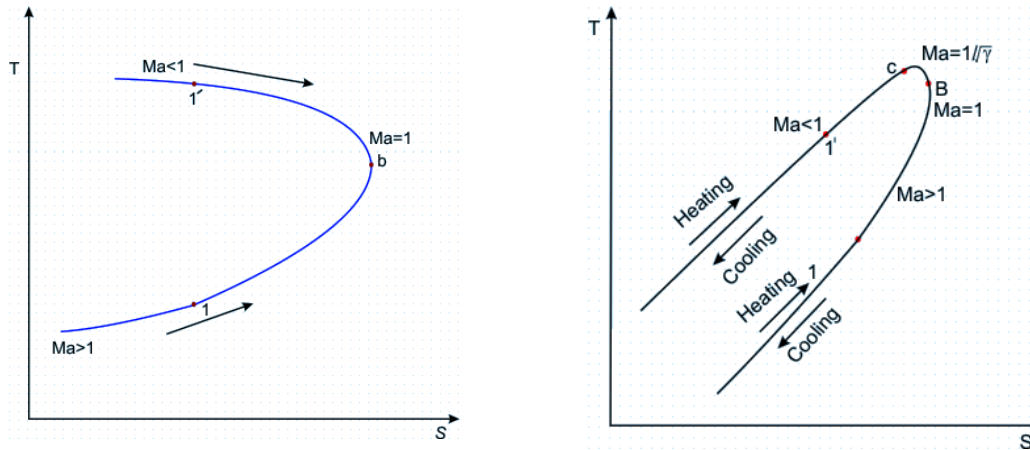

FIG. 5. To the left the Fanno line curve, to the right the Reyleigh line curve [3]

In Fig. 5. left side, the Fanno line reaches maximum entropy at point “b” and the flow is choked, $Ma=1$ (Ma : Mach number). According to the second law of thermodynamics, entropy must always increase for Fanno flow. This means that a subsonic flow entering a duct with friction will have an increase in its Mach number and if the duct is long enough, the flow is choked (with increasing length the working point moves from point 1' to b). Conversely, the Mach number of a supersonic flow will decrease until the flow is choked (with increasing length the working point moves from point 1 to b). In accordance with it each point on the Fanno line corresponds with a different Mach number, and the movement to choked flow [2;3].

For any initial (inlet section) state, duct geometry and friction coefficient (factor) the final (exit section) state can be determined easily using an online calculator called *Compressible Aerodynamics Calculator* [4], or an Android based smart phone application called *Compressible Flow Calculator*.

During the examination of the chosen combustor we used the above mentioned *Compressible Aerodynamics Calculator*. Using the known initial parameters in the inlet section of combustor, the combustor geometry and friction we can calculate the parameters in the final section (practically how much the working point 1' moves on the process curve to point b).

4. RAYLEIGH LINE FLOW

Rayleigh flow refers to frictionless, non-adiabatic flow through a constant (or near constant) area duct where the effect of heat addition or rejection is considered. Rayleigh line curve represents the relationship between the entropy and temperature of fluid flow in $S=S(T)$ coordinate system when the heat transfer is associated with entropy change.

In Fig. 5. right side, the Rayleigh line reaches maximum entropy at point “B” and the flow is choked, $Ma=1$. A subsonic flow entering a duct with heat addition will have an increase in its Mach number and at last the flow is choked.

Conversely, the Mach number of a supersonic flow will decrease with heat addition until the flow is choked at the same point. In accordance with it each point on the Rayleigh line corresponds with a different Mach number, and the movement to choked flow [2;3]. The maximum static temperature of the flow (point C), where $Ma=1/\gamma^{1/2}$.

In the same way we can presume the initial (inlet section) state is point 1' and with the heat addition the working point moves closer to point C. We can use the same *Compressible Aerodynamics Calculator* [4], like we used at Fanno line flow.

5. USING FANNO LINE FLOW TO CALCULATE THE FRICTION CAUSED PRESSURE LOSS OF TV2-117A ENGINE COMBUSTOR

The chosen rate of power is the take-off power. Earlier one of the authors made the thermodynamic cycle calculation and the analyses of the compressor stages. According to the analyses the total pressure, temperature, Mach number and adiabatic exponent (here gamma) respectively 662070 Pa, 523 K, 0,1744, 1,384 [6]. The total temperature in the exit section is 1148 K [6]. Length and the effective diameter of the chosen combustor are respectively 0.34 m and 0.086 m. The estimated friction coefficient is 0.04 [7].

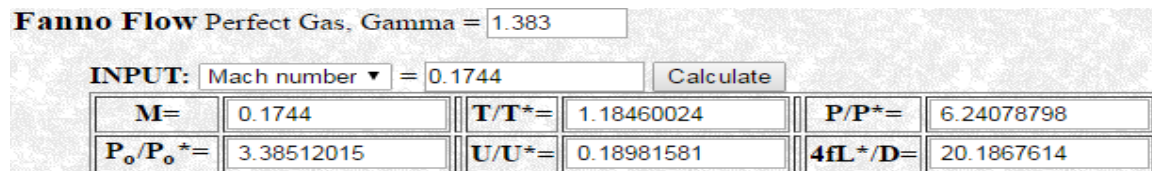

FIG. 6. Fanno variables at the inlet section of the combustor [4]

Filling the table with the necessary input data for the inlet section (Mach number and adiabatic exponent) we get the ratios of different variables, see Fig. 6.

Where: T, P, U, M : temperature, pressure, internal energy, Mach number respectively;

P_0 : the total pressure;

$T^* \dots U^*$: the value of the variables when the flow is choked ($M = 1$), the most right side point of Fanno Line curve;

P_0^* : the total pressure when the flow is choked ($M = 1$);

$4fL^*/D$: nondimensional length to diameter parameter;

f : Fanno friction factor ($1/4 \cdot$ Darcy friction factor);

L : length of the combustor;

D : effective diameter of the combustor;

σ_{sur} : pressure loss due to the friction in combustor (practically the ratio of exit and inlet total pressure).

As a next step is to modify the inlet $\left[\frac{4fL^*}{D} \right]_1$ factor (equation 1.) with the data of examined stream tube (combustor) and insert it in the next round as input data and we get the ratios of different variables for the exit section, see Fig. 7.

$$\left[\frac{4fL^*}{D} \right]_1 = 20.1867 \quad \left[\frac{4fL^*}{D} \right]_{1-2} = \frac{4 \cdot 0.04 \cdot 0.34}{0.086} = 0,6325 \quad \left[\frac{4fL^*}{D} \right]_2 = 20.1867 - 0.6325 = 19.5542 \quad (1)$$

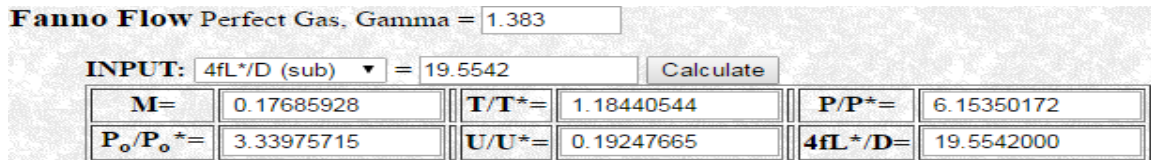

FIG. 7. Fanno variables at the exit section of the combustor [4]

We are interested in the ratio of exit total pressure and inlet total pressure. Since P_0^* refers to the total pressure when the flow is choked ($M = 1$) and that is unchanged we can create the equation 2 to determine the combustor pressure loss due to the friction.

$$\sigma_{friction} = \frac{P_{0(inlet)} / P_0^*}{P_{0(exit)} / P_0^*} = \frac{3,3397}{3,3851} \approx 0.9865 \quad (2)$$

The result of the calculation gave 0.9865 friction pressure loss, which is a normal value for that gas turbine combustor.

6. USING RAYLEIGH LINE FLOW TO CALCULATE THE HEAT TRANSFER CAUSED PRESSURE LOSS OF TV2-117A ENGINE COMBUSTOR

In this case we examine the combustor pressure loss due to temperature raise caused by the heat addition using the Rayleigh flow. This model can be applied to cases where the heat transfer is significant and the friction can be ignored.

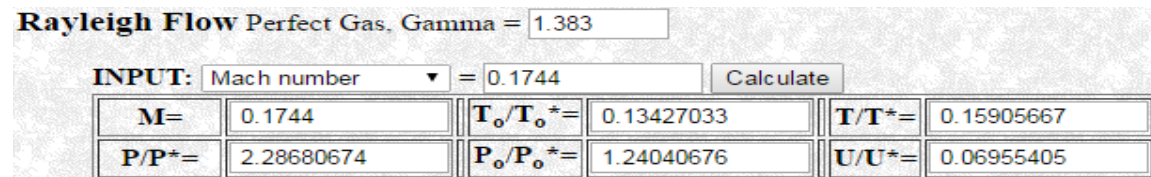

FIG. 8. Rayleigh variables at the inlet section of the combustor [4]

$$T_0^* = \frac{523K}{0,1342} = 3897K \quad p_0^* = \frac{662070Pa}{1,2404} = 533755Pa \quad \frac{T_{0out}}{T_0^*} = \frac{1148K}{3897K} = 0,2945 \quad (3)$$

Substituting the combustor inlet Mach number, we get the ratios of total variables and choked condition total variables (temperature and pressure). With these ratios we can calculate the choked condition total temperature and pressure for this combustor and the new temperature ratio for the exit section (T_{0out}/T_0^*), see equation 3. It is used in the next round of calculation as input data.

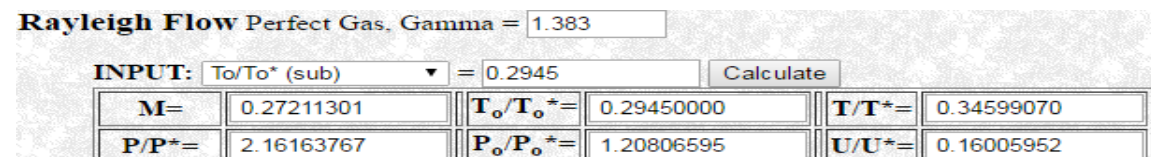

FIG. 9. Rayleigh variables at the exit section of the combustor [4]

From the new pressure ratio of total pressure and choked total pressure (p_0/p_0^*) the exit total pressure (p_{0exit}) can be calculated. Creating again the ratio of exit and inlet total pressure ratio we get the pressure loss (σ_{heat}) of the combustor due to the heat addition. Multiplying the two pressure losses with each other the total pressure loss can be calculated (σ_{Σ}).

$$p_{0_{exit}} = 1,2080 \cdot 533755 Pa = 644776 Pa \quad \sigma_{heat} = \frac{644776 Pa}{662070 Pa} \approx 0,9738 \quad \sigma_{\Sigma} \approx 0,9865 \cdot 0,9738 = 0,9607 \quad (4)$$

I used four decimal digits offered by the software, but of course in this case due to the other uncertainties it is less reasonable, but the final ~4% pressure loss is presumably close to correct considering the average pressure loss is at about 3-5%. Usually those are the values we use calculating the gas turbine thermodynamic cycles.

CONCLUSIONS

In gas turbine combustors basically two different losses can be defined. The first one is originated from the insufficient burning, which can be describe with the burning efficiency. The other one is the pressure loss, which is the main subject of our paper. The second loss also can be divided for two subtypes, namely the pressure loss caused by the friction and the pressure loss caused by the heat addition and temperature raise. However, we can also mention the fact that due to the specific nature of combustors increasing burner efficiency usually goes hand in hand with higher friction pressure loss. Considering this problem, the designer always has to make compromise to make the flow in the combustor only the necessarily turbulent providing good burner efficiency but keep the pressure loss as low as possible. Other pressure loss comes from the heat addition called heat drag. The result of this examination proved that 1/3 of the pressure loss is the friction loss while the other 2/3 is caused by the heat addition.

REFERENCES

- [1] url: http://it.wikipedia.org/wiki/File:Whittle_Jet_Engine_W2-700.JPG, (2013.07.15.).
- [2] url: http://www.ara.bme.hu/oktatas/letolt/1ljegyzet/GD_05p.htm, (2017.01.01.).
- [3] url: http://nptel.ac.in/courses/112104118/ui/Course_home-12.htm, (2017.01.01.).
- [4] url: <http://www.dept.aoe.vt.edu/~devenpor/aoe3114/calc.html>, (2017.01.01.).
- [5] A. H. LEFEBVRE, D. R. BALLAL, Gas Turbine Combustion, Alternative Fuels and Emissions, Taylor and Francis Group, 2010.
- [6] B. VARGA, A TV2-117A hajtómű termikus matematikai modellje, Diploma munka, Budapesti Műszaki Egyetem, 1990.
- [7] R. D. FLACK, Fundamentals of Jet Propulsion with Applications, Cambridge University Press, Cambridge, 2005.
- [8] url: <http://cdn.intechweb.org/pdfs/22905.pdf>, Materials for Gas Turbines–Overview, Nageswara Rao Muktinutalapati, VIT University, India, (2017.03.01.).

This work was supported by the European Regional Development Fund (GINOP 2.3.2-15-2016-00007, “Increasing and integrating the interdisciplinary scientific potential relating to aviation safety into the international research network at the National University of Public Service - VOLARE”). The project was realised through the assistance of the European Union, and co-financed by the European Regional Development Fund.

