



"HENRI COANDA"
AIR FORCE ACADEMY
ROMANIA



"GENERAL M.R. STEFANIK"
ARMED FORCES ACADEMY
SLOVAK REPUBLIC

INTERNATIONAL CONFERENCE of SCIENTIFIC PAPER
AFASES 2012
Brasov, 24-26 May 2012

THE STUDY OF THE MECHANICAL INFLUENCES ON THE PISTON WRIST ADJACENT PARTS CAUSED BY THE RESIZING OF ITS DIMENSIONS

Ionut SERBAN*, Cornel ARAMA**, Andreea ARAMA***

**"Transylvania" University, Brasov, Romania,

***"Henri Coandă" Air Force Academy, Brasov, Romania, *** freelancer, Brasov, Romania

Abstract: Nowadays the main tendency is the manufacturing of new low pollution engines. So, the "downsizing" trend is very popular today together with other auxiliary propulsion systems such as hybrid, electrical, natural gas, hydrogen etc. Another method to make an engine with high dynamic performances and low pollution is to optimise all the internal phenomena, process and components. Shortly, we are talking about an "efficient" engine. MAZDA has developed the "skyactiv" concept: as a result of their experience, the engineers tried to apply for Diesel and Otto engines the same compression ratio 14:1 and they optimised the burning process. MAZDA specialists say that the slap piston phenomenon, which appeared after applying this revolutionary technical solution, is cancelled by innovative solutions developed during ten years of experience. In conclusion, taking into account the new tendencies in engines manufacturing (three of them were shortly presented above: downsizing, efficient and skyactiv) we can talk about the increase of importance of one of the projection stages: the research and the analysis of the manufacturing influence and assembling modalities on the adjacent parts and on the functional ensemble they belong to. In this paper the influences of resizing of piston wrist on the adjacent parts will be theoretically analysed (3D modelling and FEM analysing) only from the mechanical point of view and some optimization possibilities will be highlighted.

Keywords: optimization, structures, engine, design, automotive

1. INTRODUCTION

The piston has two points of contact with the adjacent parts: the piston wrist and, using the piston rings, a lateral contact with the cylinder. Taking into account the type of assembling method of piston wrist into the eye of the connecting rod, with tightening (fixed piston wrist into the connecting rod foot) and free into the connecting rod foot, there are two types of contacts between the adjacent parts. These two types of contacts have different influences on the functional ensemble they belong to:

- piston-piston wrist bosses: the contact with sending the gas pressure force between two cylindrical surfaces which are one inside the other one, with friction in piston bosses and piston wrist fixed into the eye of the connecting rod (at the variant named "with fixed piston wrist into the foot (eye) of the connecting rod" (Fig. 1);

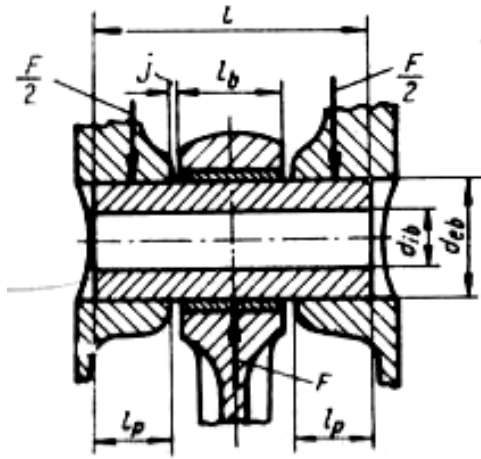

Fig. 1 – Draft of the contact between the piston boss and piston wrist (the diagram of the forces)

- (piston + piston rings) – the cylinder: the contact between two cylindrical surfaces moving alternating one to the other, with the main task to guide the piston and with lateral (horizontal) forces which, in module, have lower values than the vertical forces: F_n in Fig. 2.

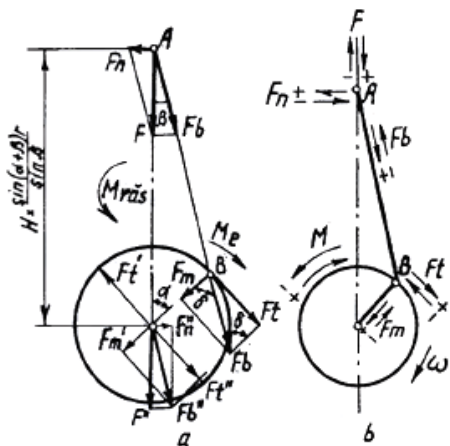

Fig. 2 – Forces and torques which act in crank gear (piston wrist centered assembling)

2. THE MODEL

The variant which is studied here is the fixed piston wrist into the eye of the connecting rod. As we can see in Fig. 6, there are two types of cylindrical areas of a mechanical contact between the adjacent parts which have the lengths: l_p and l_b . The first one, l_p , is found twice because there is the contact between the piston and the piston wrist. The

second one, l_b , is the length of contact between the piston wrist and the connecting rod. In our situation, the piston wrist is considered fixed into the eye of the connecting rod (with tightening).

It is obvious that the operating mode, sending the pressure, which is the result of burning the fuel, through the two l_p areas from the piston to the piston wrist and the friction between the piston and the piston bosses, are the most important components of this functional ensemble. The idealization of the realistic physical model and its equalization with a study model is showed in Fig. 3:

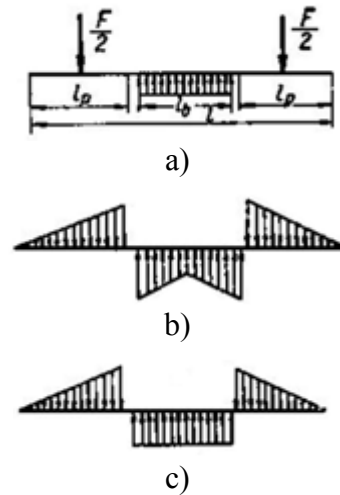

Fig. 3 – The loading diagram (the equivalent model)

Therefore, in fig. 3 we have the loading diagram (the equivalent model) between the piston bosses – the piston wrist and the piston wrist – the eye of the connecting rod where:

a) just leaning the beam and an uniform distribution of the connecting rod loading – are not enough; insufficient;

b) a more reasonable loading distribution – is sufficient;

c) a simplified loading distribution, based on b) variant – is sufficient.

Fig. 4 is a simplified example of a fixed piston wrist ensemble, without loading.



"HENRI COANDA"
AIR FORCE ACADEMY
ROMANIA



"GENERAL M.R. STEFANIK"
ARMED FORCES ACADEMY
SLOVAK REPUBLIC

INTERNATIONAL CONFERENCE of SCIENTIFIC PAPER
AFASES 2012
Brasov, 24-26 May 2012

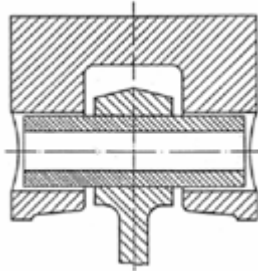

Fig. 4 – A fixed piston wrist ensemble

The influence of resizing the piston wrist length on the adjacent parts and on the functional ensemble is going to be studied in this paper using a 3D model (Fig. 5).

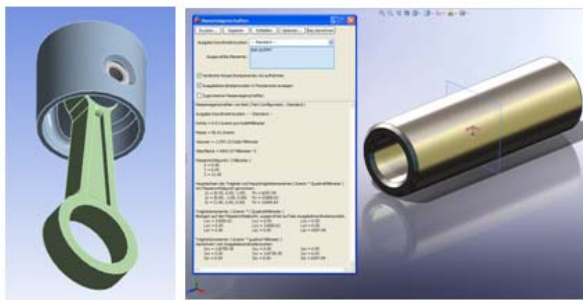

Fig. 5 – The 3D study model and the details of the piston wrist (the 62 [mm] standard variant)

The dimensions, masses and weights of the components were approximated with 1289 cm³ Otto engine (type 810-99) parts. The maximum pressure of the exhaust gases were valued to 50 daN/cm² (500 N/mm² = 50 bar). The dimensions of the piston wrist are:

- 20 mm – the external nominal diameter;
- 13 mm – the internal diameter;
- 62 mm – the length.

The mass of the piston wrist in the virtual model is 90,61 [g]. The used material is alloy steel. Its density is 0,0077 [g/mm³]. The load centre is in the middle of the part. Some properties of aluminium alloy (density = 0,0027 [g/mm³]) were attached to the piston.

In this case, the weight of the virtual model is 307,33 [g]. The mass of the connecting rod is 493,06 [g] and the density of alloy steel, which was attached, is 0,0077 [g/mm³].

The existing tightening between the eye of the connecting rod and the piston wrist is -0,02 mm / -0,04 mm.

We have to say that this analyzing is made taking into account only the mechanical loads. The thermal loads are not taken into consideration.

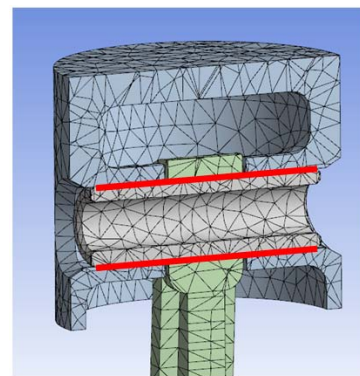

Fig. 6 – The area of the increase of stresses and deformations at the studied 3D model

3. THEORETICAL ISSUES

The phenomenon from the piston wrist modelling is made using mathematical formulas. In this situation, the analysing of the phenomenon is not going to be made in detail with the projecting data of the piston wrist. We are going to refer only to the mathematical formulas which describe the deformations of the piston: the bending, the elliptic section deformation and the unit pressure decreasing between the piston wrist and the piston bosses.

The formula of the piston wrist bending is:

$$f_1 = \frac{(p_z - p_j) D^2 (l - 2c)^2 l}{60 E (d^4 - d_0^4)} \quad (1)$$

where:

l – the piston wrist length;

c – half of the effective length of the piston wrist;

D – the piston wrist diameter;

E – the coefficient of elasticity;

p_z – the pressure of the exhaust gas;

p_j – the inertial forces.

The piston deformation contains an elliptic component. Its formula is:

$$f_2 = \frac{\pi(p_z - p_j)D^2(d + d_0)^3}{320EI(d - d_0)^3} \quad (2)$$

The aim of the optimization process is to decrease the unit pressure which is developed between the piston wrist and the piston bosses and it is expressed in the formula:

$$q = \frac{p_z - p_j}{2dl_p} \quad (3)$$

where l_p is the length of the piston wrist.

The aim of the study is:

- to analyze an ensemble where the length of the piston wrist is resized;
- the increasing of the values of the tensions and of the maximum deformations which appear in the contact area between the adjacent parts;
- drawing some conclusions.

The variation of the piston wrist length causes the variation of pressures and the deformations from the piston's bosses. In this situation, the piston-piston wrist-connecting rod ensemble will have a different bending behaviour.

4. SIMULATION AND OPTIMIZATION

The maximum developed pressure (which was caused by burning fuel and it is approximated with 50 bar) is presented in Fig. 7. The pressure distribution on the surface of the piston is also made normally (red colour).

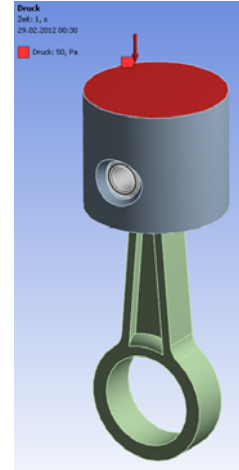

Fig. 7 – The loading of piston-the piston wrist-connecting rod ensemble (the gas pressure force)

The state of induced stress (von Mises), in [Pa], for the genuine manufacturing variant is presented in Fig. 8:

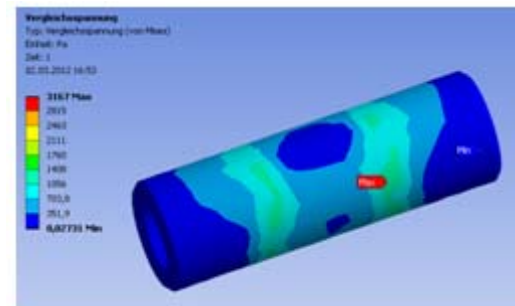

Fig. 8 – The tensions which appeared into the piston wrist

The deformation state is presented in Fig. 9:

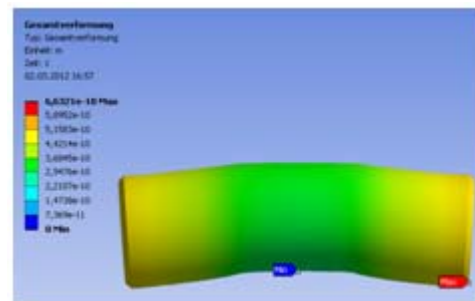

Fig. 9 – The deformation state that appeared into the piston wrist

The von Mises variation diagram of tensions from piston's bosses is presented in Fig. 10:



INTERNATIONAL CONFERENCE of SCIENTIFIC PAPER
AFASES 2012

Brasov, 24-26 May 2012

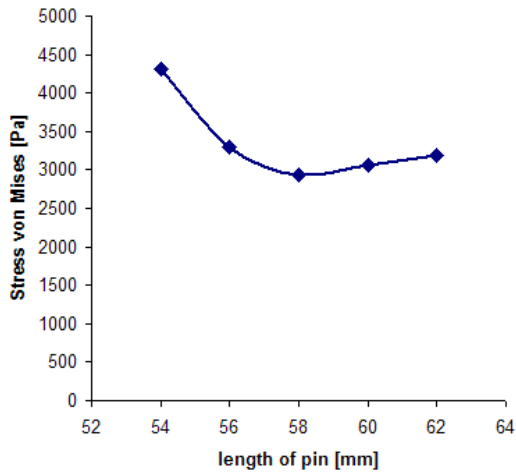

Fig. 10 – The tensions which appeared into the piston's bosses

The variation diagram of the piston wrist tensions is presented in Fig. 11:

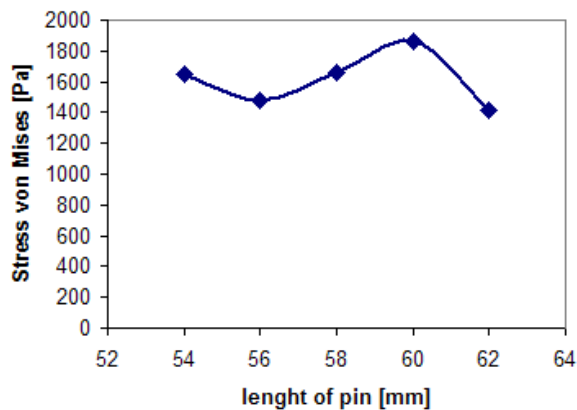

Fig. 11 – The tensions which appeared into the piston wrist, in the area between the piston's bosses and the eye of the connecting rod

The diagram of the deformation which appeared into the piston wrist, in the area between the piston's bosses and the eye of the connecting rod, is presented in Fig. 12:

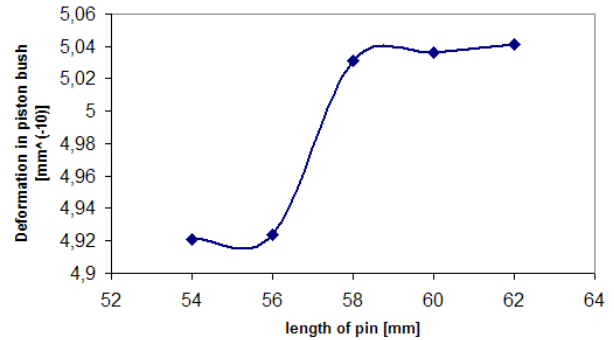

Fig. 12 - The deformation which appeared in the piston wrist, in the area between the piston's bosses and the eye of the connecting rod

The state of tensions and of deformations of the piston for the variant with piston wrist (62 mm initial length) and the highlighting of the critical areas:

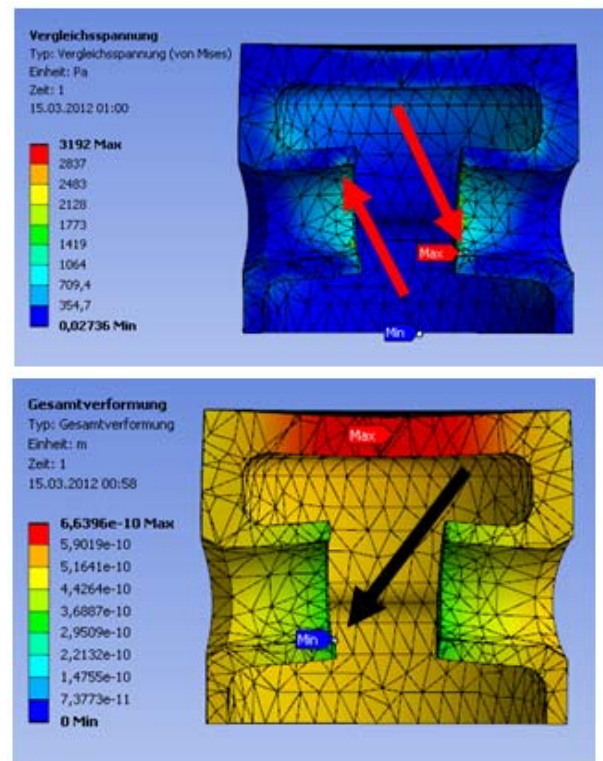

Fig. 13 - The state of tensions and deformation of the piston

The state of tensions and deformation of the piston wrist for the length 62 mm is presented in Fig. 14:

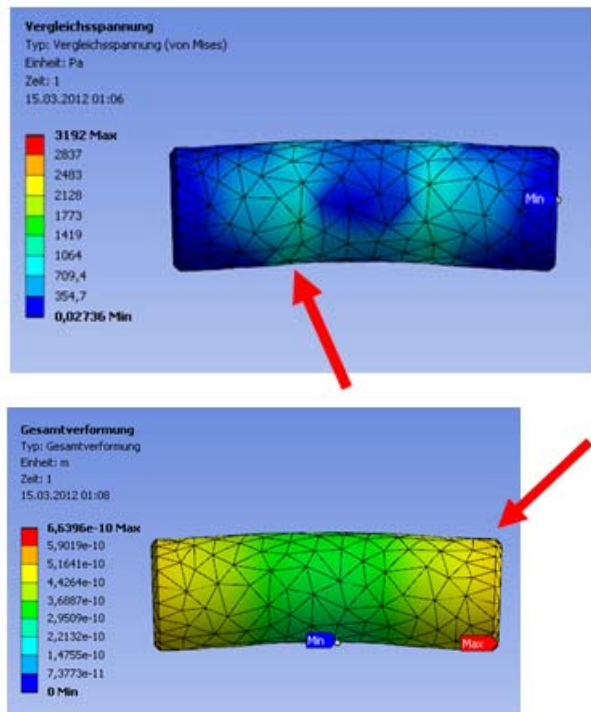

Fig. 14 - The state of tensions and deformations of the piston wrist

The state of tensions was presented in the upper images of figures 13 and 14 and the state of deformations was presented in the bottom images of the same figures.

5. CONCLUSIONS

The study gives us some conclusions about the behaviour of the parts and the possibilities to optimize them. Therefore, the decreasing of the piston wrist length causes the increasing of

the piston wrist's tensions into the piston's bosses (Fig. 10).

The tensions from the area between the piston's bosses and the eye of the connecting rod vary following an approximately sinusoidal curve. Their tendency is to increase to the same extent with the decreasing of length (Fig. 11).

The deformation of the piston wrist (Fig. 12) decreases with the decrease of its length. The decreasing of the piston wrist's length also causes the moving down (to the crankshaft) of the load center of the ensemble. This change influences the distribution formula of the connecting rod weights for the vibration calculus. We could continue and we could analyze the deformation stage in the cross section of the piston wrist (an elliptic deformation). Thus, other conclusions could be formulated.

BIBLIOGRAPHY

1. Bobescu, G. s.a. *Motoare pentru automobile si tractoare*, Vol. II, Editura "Tehnică", Chişinău, 2000;
2. Brebenel. A s.a. *Autoturismul Dacia 1300*, Ediţia a II-a, Editura "Tehnică", Bucureşti, 1978;
3. Schumacher, A. *Optimierung mechanischer Strukturen - Grundlagen und industrielle Anwendungen*, Springer Verlag, Berlin, 2005;
4. Serban, I. s.a. *Considerations about optimized cad design application for the automotive and engine's mechanical structures*, CONAT Paper, Transilvania University of Brasov, 2011.